

IP Link Pro xi Series

PRO SERIES CONTROL PROCESSORS



Full-Featured Control Processors with Enhanced Speed and Security

- A Control processors for use with TouchLink Pro touchpanels, Network Button Panels, eBUS devices, and IPL EXP expansion interfaces
- A Enhanced performance with greater processing power and up to four times the memory of our IP Link Pro series
- A Multiple AV Network ports provide versatile control options for a wide range of system sizes
- A Support secure industry standard communication protocols
- A Powerful software available for configuration, programming, and enterprise-wide resource management
- A Compact enclosures mount on a rack, under furniture, or on a DIN rail

Extron



IPCP PRO XI SERIES CONTROL PROCESSORS

Our powerful new IP Link Pro xi Series control processors deliver a huge leap in performance and capabilities, setting new standards for Extron control. With up to four times more memory and significantly-enhanced processing power for increased deployment speeds and improved runtime functionality, this new series is designed to excel in even the most demanding AV applications. In addition to increases in performance, these new processors feature advanced security standards and Gigabit Ethernet, which ensures compatibility with multiple TouchLink Pro touchpanels, Network Button Panels, and IPL EXP expansion interfaces using a standard network infrastructure. The new IPCP Pro xi Series control processors are an ideal choice for controlling multiple devices and control signal types within today's most challenging control system designs.

Extron Control - More Choices. Better Results.

Whether it is the convenience of configuration with the industry's most powerful configuration-based control system solution, or the unbridled freedom of Extron Control System Programming, you'll be confident that you have the right control solution for any AV application.

Global Configurator Professional

Global Configurator® is Extron's most powerful and versatile control system configuration software. It is designed to be used exclusively with Extron Pro Series Control products. Powerful features, such as conditional logic, variables, and macros provide greater flexibility for more elaborate control system designs. Global Configurator has two modes. Global Configurator Plus is ideal for smaller applications requiring one control processor and one control interface. Global Configurator Professional is suited for applications requiring multiple control processors, enhanced



functionality, and advanced configuration. Access to Global Configurator Professional requires an individual to successfully complete ECP Certification.

Global Scripser

Global Scripser® is Extron's powerful and versatile control system programming software. This feature-rich integrated development environment is used to program Extron Pro Series control systems, and utilizes the easy-to-learn Python scripting language. Global Scripser includes an Extron-exclusive Python library - ControlScript®, that is designed to increase the productivity of AV programmers through incorporating functions used in AV control system projects, as well as helpful documentation, reference material, and sample code. Extron built Global Scripser and the ControlScript Python libraries with programmers in mind. Working together, these components make it easier than ever to develop refined and innovative programmable control systems.

Unlock Powerful New Features with LinkLicense

Extron LinkLicense® is a quick, cost-effective way for people to add even more powerful capabilities to Extron products. Each type of LinkLicense unlocks a unique set of features that add convenience and expand the functionality available in your system.

Enterprise-Level Resource Management

GlobalViewer® Enterprise server-based software simplifies AV system resource management with intuitive control for hundreds of common AV tasks. Whether you're working with 5 or 5,000 rooms, GlobalViewer Enterprise provides a powerful, flexible way to manage, monitor, and control nearly any device over a standard network. Support teams will appreciate the agility and flexibility GlobalViewer Enterprise provides to access usage data, create reports, and control the system from any computer on the LAN or WAN.



IPCP PRO XI SERIES CONTROL PROCESSORS



IR receiver
For creating customized IR drivers

DC power ports
Four switched DC power ports for powering remote devices

Internal power supply
With worldwide compatibility

LED indicators
Assist in monitoring and troubleshooting of control ports

Quad core processor and four times more memory
For increased upload speeds, faster runtime performance, and more sophisticated projects

eBUS port
For connecting eBUS-enabled devices

Dual Gigabit Ethernet port
For network control and management

AV LAN Port
Allows AV devices to be isolated from the corporate network, and is secure from outside interference or intrusion

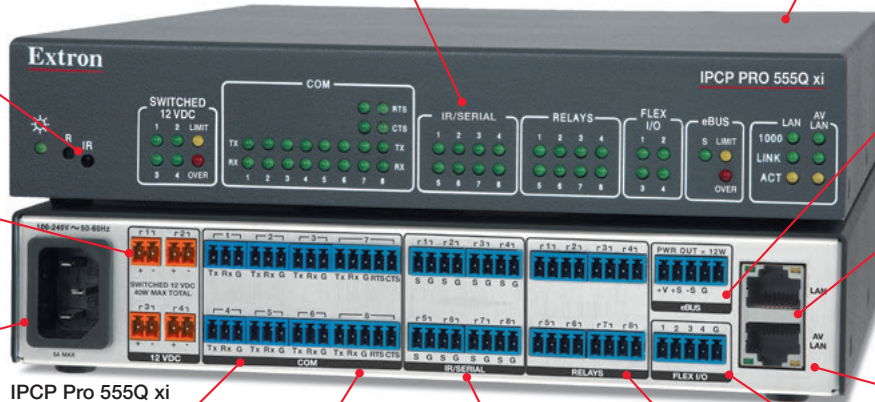

Serial ports
Six bidirectional RS-232 serial ports

Serial ports
Two bidirectional RS-232/RS-422/RS-485 serial ports

Eight IR/Serial ports
Eight IR/Serial ports for control of source devices

Eight relays
For controlling room functions

Four flex I/O ports
Allow for system automation and feedback

The IPCP Pro xi Series of high performance control processors is designed to keep pace with the increasing size and complexity of today's AV control systems and delivers ultra-fast, dependable, and secure performance for your organization's AV. With up to four times more memory and significantly-enhanced processing power for increased deployment speeds and improved runtime functionality, this new series is designed to excel in even the most demanding AV applications. In addition to increases in performance, these new processors feature advanced security standards and Gigabit Ethernet, which ensures compatibility with multiple TouchLink Pro touchpanels, Network Button Panels, and IPL EXP expansion interfaces using a standard network infrastructure.

SERIES COMMON FEATURES

- ▶ Supports TouchLink Pro touchpanels, Network Button Panels, and IPL EXP expansion interfaces
- ▶ Supports secure industry standard communications protocols
- ▶ Ethernet monitoring and control on each Ethernet port
- ▶ Central Deployment - Use the primary control processor to deploy all system files, configurations and programs
- ▶ Supports popular BMS – Building Management System protocols, such as BACnet, KNX, and DALI
- ▶ Supports 10/100/1000Base-T
- ▶ Supports Ethernet-controllable devices
- ▶ Supports LinkLicense® for User Interfaces
- ▶ Automatic clock synchronization allows touchpanel to display the accurate time and date
- ▶ Supports control system synchronization
- ▶ Front panel port status indicators
- ▶ Multi-level password protection
- ▶ Fully customizable using Extron control system software
- ▶ Our extensive library of Global Configurator device drivers and Global Scriptor modules support devices from a broad range of manufacturers, streamlining configuration and programming



IPCP Pro 555Q xi

Unique Features

- Quad-core processor and four times more memory
- AV LAN port allows AV devices to be isolated from the corporate network
- Six bidirectional RS-232 serial ports with software handshaking
- Two bidirectional RS-232/RS-422/RS-485 serial ports with hardware and software handshaking
- Eight IR/Serial ports for one-way control of external devices
- Four Flex I/O ports
- Eight relays for controlling room functions
- Four independently switched 12 VDC outputs
- eBUS port for connecting eBUS button panels and accessories

Model	Version Description	Part Number
IPCP Pro 555Q xi	IPCP Pro xi Control Processor	60-1917-01
IPCP Pro 555Q xi	IPCP Pro xi Control Proc., LL UI Upgrade	60-1917-01A



IPCP Pro 360Q xi

Unique Features

- Quad core processor and four times more memory
- Three AV LAN ports allow AV devices to be isolated from the corporate network
- AV LAN ports provide PoE+ to external devices
- Two bidirectional RS-232 serial ports with software handshaking
- One bidirectional RS-232/RS-422/RS-485 serial port with hardware and software handshaking
- Two IR/Serial ports for one-way control of external devices
- Four Digital I/O ports
- Four relays for controlling room functions
- eBUS port for connecting eBUS button panels and accessories

Model	Version Description	Part Number
IPCP Pro 360Q xi	IPCP Pro xi Control Processor	60-1916-01
IPCP Pro 360Q xi	IPCP Pro xi Control Proc., LL UI Upgrade	60-1916-01A



IPCP Pro 255Q xi

Unique Features

- Quad core processor and four times more memory
- AV LAN port allows AV devices to be isolated from the corporate network
- One bidirectional RS-232 serial port with software handshaking
- One bidirectional RS-232/RS-422/RS-485 serial port with hardware and software handshaking
- One IR/Serial port for one-way control of external devices
- Four Digital I/O ports
- Two relays for controlling room functions
- Remote volume control port for the Extron MPA Series and select XTRA™ Series amplifiers
- eBUS port for connecting eBUS button panels and accessories

Model	Version Description	Part Number
IPCP Pro 255Q xi	IPCP Pro xi Control Processor	60-1914-01
IPCP Pro 255Q xi	IPCP Pro xi Control Proc., LL UI Upgrade	60-1914-01A



IPCP PRO XI SERIES CONTROL PROCESSORS

IPCP Pro 355DRQ xi

Unique Features

- Quad core processor and four times more memory
- Securely mounts to an industry-standard DIN rail
- AV LAN port allows AV devices to be isolated from the corporate network
- Two bidirectional RS-232 serial ports with software handshaking
- One bidirectional RS-232/RS-422/RS-485 serial port with hardware and software handshaking
- Two IR/Serial ports for one-way control of external devices
- Four Digital I/O ports
- Four relays for controlling room functions
- DHCP server for AV LAN
- eBUS port for connecting eBUS button panels and accessories



Model	Version Description	Part Number
IPCP Pro 355DRQ xi	IPCP Pro xi Control Processor, DIN Rail	60-1915-01
IPCP Pro 355DRQ xi	IPCP Pro xi Control Proc., DIN Rail, LL UI Upgrade	60-1915-01A

IPCP Pro 550 xi

Unique Features

- Upgraded single core processor and two times more memory
- Six bidirectional RS-232 serial ports with software handshaking
- Two bidirectional RS-232/RS-422/RS-485 serial ports with hardware and software handshaking
- Eight IR/Serial ports for one-way control of external devices
- Four Flex I/O ports
- Eight relays for controlling room functions
- Four independently switched 12 VDC outputs
- eBUS port for connecting eBUS button panels and accessories



Model	Version Description	Part Number
IPCP Pro 550 xi	IPCP Pro xi Control Processor	60-1913-01
IPCP Pro 550 xi	IPCP Pro xi Control Proc., LL UI Upgrade	60-1913-01A

IPCP Pro 350 xi

Unique Features

- Upgraded single core processor and two times more memory
- Two bidirectional RS-232 serial ports with software handshaking
- One bidirectional RS-232/RS-422/RS-485 serial port with hardware and software handshaking
- Two IR/Serial ports for one-way control of external devices
- Four Digital I/O ports
- Four relays for controlling room functions
- Integrated three port network switch
- eBUS port for connecting eBUS button panels and accessories



Model	Version Description	Part Number
IPCP Pro 350 xi	IPCP Pro xi Control Processor	60-1912-01
IPCP Pro 350 xi	IPCP Pro xi Control Proc., LL UI Upgrade	60-1912-01A

IPCP Pro 250 xi

Unique Features

- Upgraded single core processor and two times more memory
- One bidirectional RS-232 serial port with software handshaking
- One bidirectional RS-232/RS-422/RS-485 serial port with hardware and software handshaking
- One IR/Serial port for one-way control of external devices
- Four Digital I/O ports
- Two relays for controlling room functions
- Remote volume control port for the Extron MPA Series and select XTRA™ Series amplifiers
- eBUS port for connecting eBUS button panels and accessories



Model	Version Description	Part Number
IPCP Pro 250 xi	IPCP Pro xi Control Processor	60-1911-01
IPCP Pro 250 xi	IPCP Pro xi Control Proc., LL UI Upgrade	60-1911-01A

IPCP Pro PCS1 xi

Unique Features

- Upgraded single core processor and two times more memory
- Intelligent current sensing with alarm
- Outlet status retention during power loss
- One male AC input and one female AC output - both using IEC connections
- Easily-accessible, front panel circuit breaker adds over-current protection for remotely controlled connected devices
- One bidirectional RS-232 serial port with software handshaking
- One IR/Serial port for one-way control of external devices
- Three digital I/O ports
- Supports control system synchronization
- eBUS port for connecting eBUS button panels and accessories



Model	Version Description	Part Number
IPCP Pro PCS1 xi	IPCP Pro xi Control Processor	60-1910-01
IPCP Pro PCS1 xi	IPCP Pro xi Control Proc., LL UI Upgrade	60-1910-01A

IPCP Pro S1 xi

Unique Features

- Upgraded single core processor and two times more memory
- One bidirectional RS-232/RS-422/RS-485 serial port with hardware and software handshaking
- Compact, 1U, quarter rack width metal enclosure
- External Extron Everlast™ power supply included



Model	Version Description	Part Number
IPCP Pro S1 xi	IPCP Pro xi Control Processor	60-1979-01
IPCP Pro S1 xi	IPCP Pro xi Control Proc., LL UI Upgrade	60-1979-01A



Control System Expansion Interfaces

An Easy and Secure Way to Expand Your AV Control System

The Extron IPL EXP I/O Series of control system expansion interfaces are a convenient way to put extra control ports and functionality just where you need them in your system. These expansion interfaces pair exclusively with our IPCP Pro xi Series of control processors, which are securely configured with Global Configurator Professional or programmed with Global Scripter. They feature the convenience of PoE and can be controlled, monitored, and accessed over your network. All these compact control expansion solutions are housed in durable 1U quarter rack enclosures and offer a broad variety of port types as well as mounting options.

IPL EXP Series - Common Features:

- Secure Platform Devices that provide control system expansion for Extron IPCP Pro xi Series control processors
- PoE compatible
- Support secure industry standard communication protocols, including 802.1X
- Fully customizable using Extron control system software — Global Configurator Plus, Global Configurator Professional, or Global Scripter.
- Extensive library of Pro Series device drivers and modules for use with Global Configurator and Global Scripter respectively
- Compact, 1U quarter rack enclosures with ZipClip™ 200 mounting capability
- Support control system synchronization
- Manage, monitor, and control AV devices using a standard Ethernet network
- Mount directly to Extron basic and universal rack shelf products or a variety of surfaces, including rack rails, tables, lecterns, projector poles, and table legs



IPL EXP S2

Unique Features

- Two bidirectional RS-232 serial ports with software handshaking
- High-impact plastic enclosure

Model	Version Description	Part Number
IPL EXP S2	Two Serial Ports	60-1905-01



IPL EXP S5

Unique Features

- Five bidirectional RS-232 serial ports with software handshaking
- High-impact plastic enclosure

Model	Version Description	Part Number
IPL EXP S5	Five Serial Ports	60-1906-01



IPL EXP RIO8

Unique Features

- Eight digital I/O ports
- Eight relays
- Four 12VDC and four 24VDC output power ports
- UL 2043 plenum rated
- Metal enclosure

Model	Version Description	Part Number
IPL EXP RIO8	D I/O, Relays, Power	60-1907-01



IPL EXP 200

Unique Features

- Two bidirectional RS-232 serial ports with software handshaking
- One unidirectional IR/Serial port
- Four digital I/O ports
- One eBUS port
- High-impact plastic enclosure

Model	Version Description	Part Number
IPL EXP 200	Serial, IR/S, Relays, D I/O, eBUS	60-1908-01



APPLICATION DIAGRAMS

CONFERENCE ROOM WITH IPCP PRO 250 XI, IPL EXP RIO8, AND TLP PRO 300M

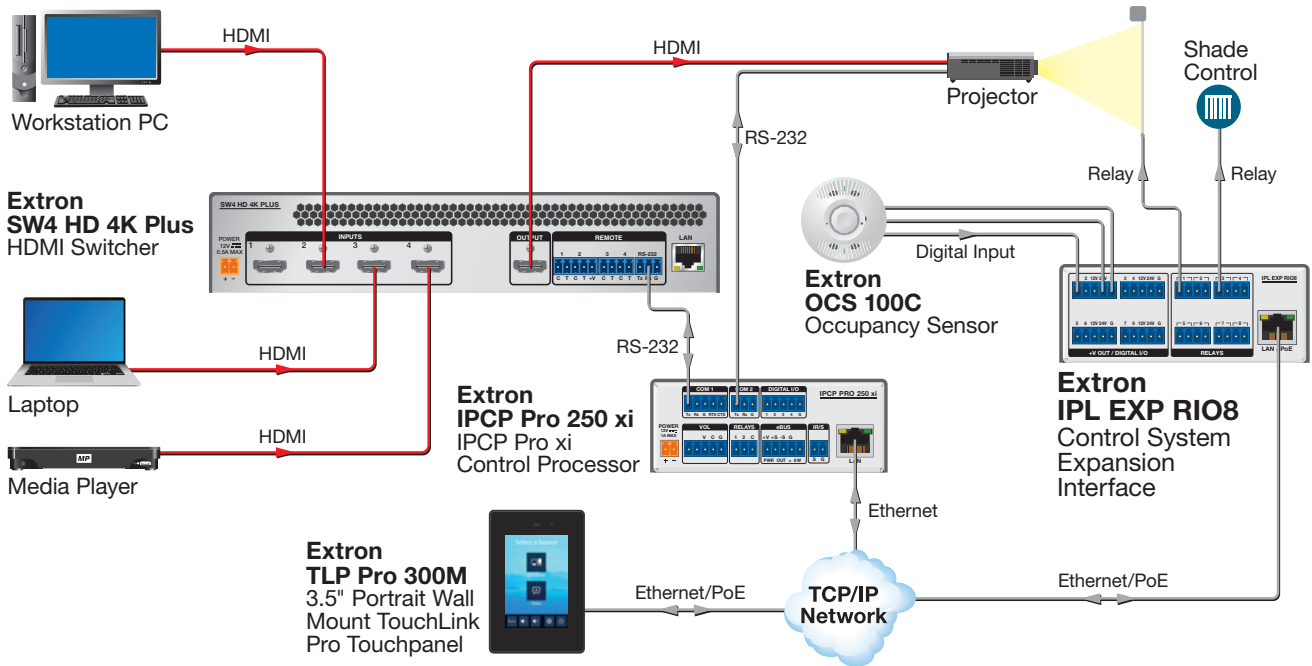

LECTURE HALL WITH IPCP PRO 555Q XI AND TLP PRO 1025T

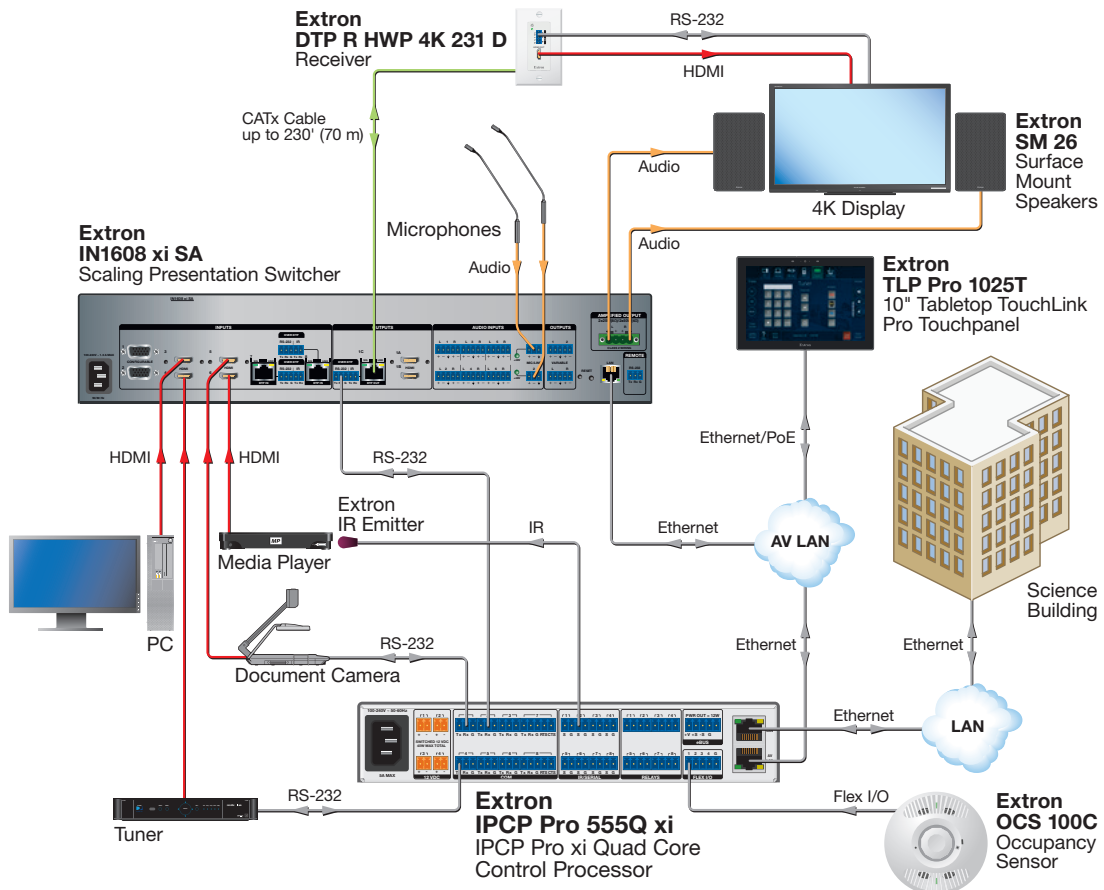

IP LINK PRO XI FEATURES

IPCP Pro xi Series Control Processors

	IPCP Pro PCS1 xi	IPCP Pro 250 xi	IPCP Pro 255Q xi	IPCP Pro 350 xi	IPCP Pro 355DRQ xi	IPCP Pro 360Q xi	IPCP Pro 550 xi	IPCP Pro 555Q xi
Features								
Microprocessor	Single Core	Single Core	Quad Core	Single Core	Quad Core	Quad Core	Single Core	Quad Core
Memory	RAM 1 GB Flash 8 GB	RAM 1 GB Flash 8 GB	RAM 2 GB Flash 8 GB	RAM 1 GB Flash 8 GB	RAM 2 GB Flash 8 GB	RAM 2 GB Flash 8 GB	RAM 1 GB Flash 8 GB	RAM 2 GB Flash 8 GB
Bidirectional RS-232, RS-422, RS-485	—	1	1	1	1	1	2	2
Bidirectional RS-232	1	1	1	2	2	2	6	6
Configurable IR/Serial	1	1	1	2	2	2	8	8
Flex I/O	—	—	—	—	—	—	4	4
Digital Inputs/Outputs	3	4	4	4	—	—	—	—
Relays	—	2	2	4	4	4	8	8
Switched 12 VDC Power Ports	—	—	—	—	—	—	4	4
eBUS	•	•	•	•	•	•	•	•
Remote Volume Control Port	—	1	1	—	—	—	—	—
AV LAN	—	—	•	—	•	•	—	•
Integrated IR Learner	—	•	•	•	•	•	•	•
Integrated Switch	—	—	—	•	—	•	—	—
PoE+ Output	—	—	—	—	—	•	—	—
Mounting	1U, 1/4 Rack	1U, 1/4 Rack	1U, 1/4 Rack	1U, 1/2 Rack	DIN Rail	1U, 1/2 Rack	1U, 1/2 Rack	1U, 1/2 Rack

IPL EXP I/O Expansion Interfaces

	IPL EXP S2	IPL EXP S5	IPL EXP 200	IPL EXP RIO8
Features				
Bidirectional RS-232	2	5	2	—
Configurable IR/Serial	—	—	1	—
Digital I/O	—	—	4	8
Relays	—	—	2	8
eBUS	—	—	1	—
12V DC Power Ports	—	—	—	4
24V DC Power Ports	—	—	—	4
PoE Powered	•	•	•	•
Plenum Rated	—	—	—	•
Mounting	1U, 1/4 Rack, Plastic	1U, 1/4 Rack, Plastic	1U, 1/4 Rack, Plastic	1U, 1/4 Rack, Metal



Global Configurator Software

Global Configurator® Professional is Extron's most powerful and versatile control system configuration software. It is designed to be used exclusively with Extron Pro Series control systems, and helps streamline integration within today's demanding AV control environments. Powerful features, such as conditional logic, variables, and macros provide greater flexibility for more elaborate control system designs. Global Configurator has two modes. Global Configurator Plus is ideal for smaller scale applications requiring one control processor and one control interface. Global Configurator Professional is suited for applications requiring multiple control processors, enhanced functionality, and advanced configuration.

Easy and Secure System Expansion

Global Configurator allows users to utilize up to eight IPL EXP expansion interfaces in GC Plus and 32 IPL EXP expansion interfaces in GC Pro, placing control ports right where you need them. This gives you a variety of port types within these secure platform devices for a broad range of applications. Grouping the IPCP Pro xi control processors reduces the need for long RS-232 cable runs, as the group can span several rooms instead of being limited to a single room. This feature enables system expansion and ideally serves advanced systems that require more control ports than are offered in a single control processor.

Drivers Enable Greater System Capabilities

Serial over Ethernet drivers expand control capabilities through devices such as Extron XTP Systems that are capable of IP to serial direct port control. In addition, Global Configurator allows system designers to configure Extron control processors for the latest Building Management System protocols, including BACnet, KNX, and DALI. Modern BMS allow for centralized monitoring and control of mechanical and electrical systems that include HVAC, lighting, power, fire, and security systems.

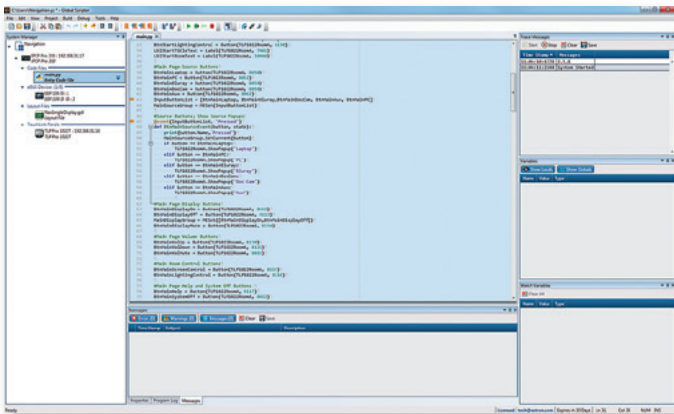

Global Scripter

Global Scripter® is Extron's powerful and versatile control system programming software. This feature-rich integrated development environment is used to program Extron Pro Series control systems, and utilizes the easy-to-learn Python scripting language. Global Scripter includes an Extron-exclusive Python library - ControlScript®, that is designed to increase the productivity of AV programmers through incorporating

functions used in AV control system projects, as well as helpful documentation, reference material, and sample code.

Extron built Global Scripter and the ControlScript Python libraries with programmers in mind. Working together, these components make it easier than ever to develop refined and innovative programmable control systems.

Python and the Pro Series Control Systems Platform

Python is a clean, easily readable and easily editable object-oriented programming language. With ample documentation available in print and on the Internet, there are numerous programming resources for novices and experts alike. As an interpreted language, Python does not require compiling and offers a quicker workflow from editing code to testing a program. Instructions are executed immediately, and functions can be added or modified at runtime.

GlobalViewer Enterprise

GlobalViewer® Enterprise - GVE software simplifies AV system resource management with intuitive control for hundreds of common AV tasks. Whether you're working with 5 or 5000 rooms, GVE provides a powerful, flexible way to manage, monitor, and control nearly any device over a standard network. Support teams will appreciate the agility and flexibility GVE provides to access usage data, create reports, and control the system from any computer on the network.

Enterprise-Wide Scheduling and Monitoring

GVE simplifies system management across the enterprise through global schedules and conditional monitors. Support teams can schedule system actions and proactively monitor the status of AV equipment. These tools help provide significant time and cost savings.

Valuable AV Data Management

GlobalViewer Enterprise includes a SQL-based data repository for logging device and room data. This data is gathered for valuable management reports covering network connections, device usage, and AV equipment inventory.



INTERNET EXPLORER



MOZILLA FIREFOX



GOOGLE CHROME



APPLE SAFARI



Toolbelt

The Extron Toolbelt utility is a powerful stand-alone Windows application created for the management and troubleshooting of Extron control systems. This utility allows users to easily perform several different tasks such as: change device network settings, add an email server, upload firmware, view trace messages, remotely reboot control products, and much more from a single application. Devices on the network can be automatically discovered or manually added if desired. Toolbelt also provides users with memory usage, device run time, author of the current project, and software version used.

Features

- Manage and troubleshoot Extron control products
- Use Auto Discovery to find control products located on the same subnet as Toolbelt or manually add routable control products using the Add button
- View and change network settings, mail server information, and user permissions
- Discover eBUS panels connected to control processors and diagnose addressing, connectivity, and voltage issues

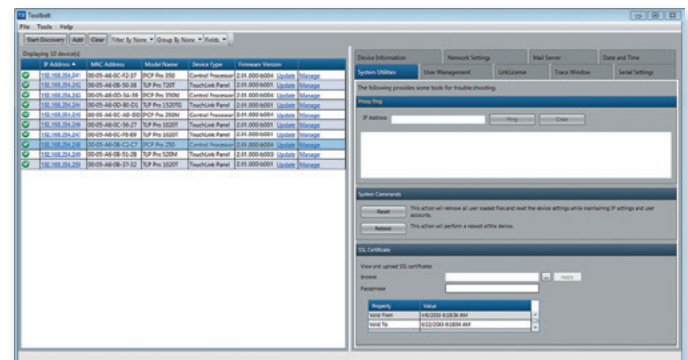

- Configure SNMP and 802.1x settings and manage security certificates
- Trace window allows users to view control system messages passed between connected devices for troubleshooting
- Upload LinkLicense to control processors
- Remotely reboot Extron control processors and MediaLink Plus controllers
- Proxy Ping provides a means to test a connection between a control processor and another network device

LINKLICENSE FOR USER INTERFACES

The LinkLicense for user interfaces upgrade is an easy way for people to use their mobile devices or computers as primary control interfaces. Systems using a standalone Extron control processor or switcher with embedded control processor, HC 400 Series systems, and select TeamWork® collaboration systems can all benefit from this upgrade.

When LinkLicense for User Interfaces is combined with one of these products and the Extron Control App, BYOD room control is easier than ever. Simply open the App or Web browser and gain instant access to the room's AV. The intuitive, custom-built interface allows full control of source devices, sound, lighting - anything you can control with a standard touchpanel, but with the convenience of using your own device.



Start Using LinkLicense for User Interfaces in Three Easy Steps:

Step 1

Purchase an Extron control processor with a LinkLicense included or add a LinkLicense to an existing control processor.

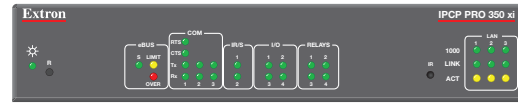

Step 2

Create a custom user interface and configure your control system using Global Configurator Plus or Professional.



Step 3

Upload your user interface designs and use your mobile device or computer to control the system.

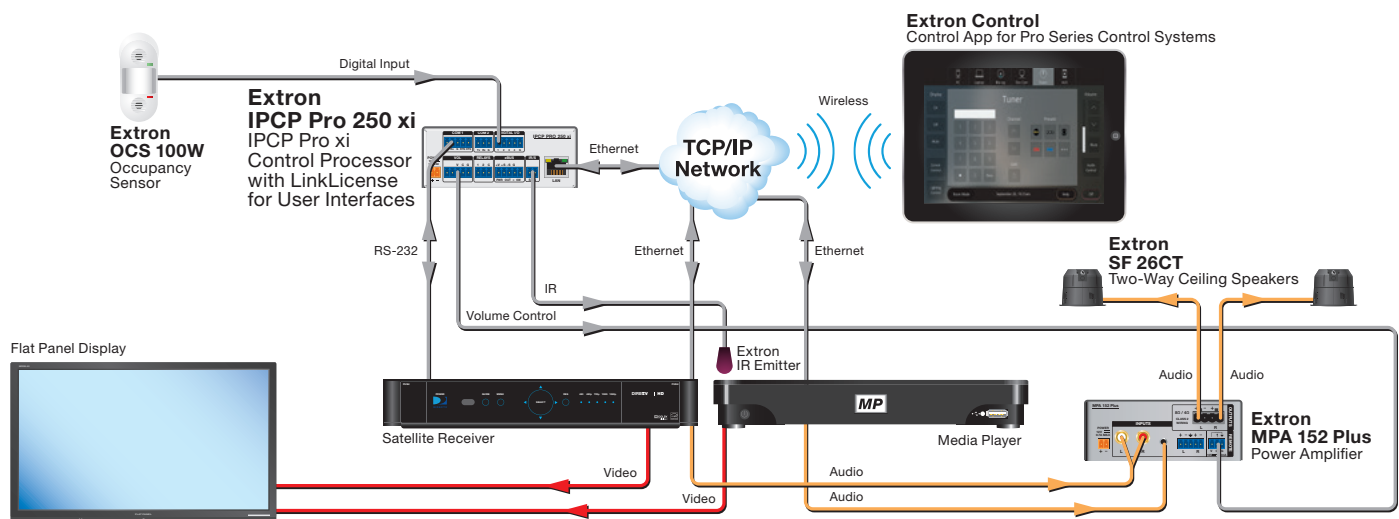



Transform your TouchLink Pro Touchpanel into a Powerful All-in-One Control System

Extron LinkLicense for TLP Control Processor and the TLCA 1 TouchLink Control Port Expansion Adapter are two powerful Pro xi Series control options that will transform your wall mount, tabletop, and Cable Cubby TouchLink Pro touchpanels into powerful, all-in-one control systems. These innovative tools add flexibility and power to our latest TouchLink Pro touchpanels, including the TLP Pro 525 Series, TLP Pro 725 Series, TLP Pro 1025 Series and TLP Pro 300M.

Integrated touchpanel control systems provide many advantages including simpler system designs and streamlined system deployment. In addition, when you introduce a touchpanel control system into a room where an Extron touchpanel and a control processor already exists, you will be able to remove the control processor from the system and use it elsewhere.

LinkLicense for TLP Control Processor

Extron LinkLicense for TLP Control Processor is a powerful, easy way to turn your TouchLink Pro touchpanel into a full-featured, standalone control system. With this LinkLicense, you can control your AV devices via Ethernet directly from the Ethernet port on the touchpanel. And, by adding the optional TLCA 1 TouchLink Control Port Expansion Adapter, you can control a broad range of system devices directly from the touchpanel using the variety of ports on the control adapter.



TLCA 1

The Extron TLCA 1 is a TouchLink Control Port Expansion Adapter designed to add traditional control ports to your touchpanel installed with LinkLicense for TLP Control Processor. It features two bidirectional serial ports, one digital input, one IR port, and two relays for control of sources, directly at the touchpanel.



Model	Version Description	Part Number
LinkLicense	TLP Control Processor Upgrade	79-2577-01
TLCA 1	TouchLink Control Port Expansion Adapter	60-1748-10





Extron Control Systems Certification Programs Establish Your Knowledge of Extron Control Systems

Extron offers three control systems certification programs designed to prepare individuals to successfully deploy and maintain customized AV control systems built around our Pro Series control systems.

Certification Comparison



Extron Control Specialist - ECS

Extend Your Ability to Customize and Manage Extron Pro Series Systems

Course Content

ECS is a two-day course that consists of the following general categories:

- Learn Global Configurator Plus, and use its powerful capabilities to configure and manage Extron Pro Series control systems
- Control system design concepts
- Configure a wide range of room control functions using Global Configurator Plus
- Create custom control interfaces using GUI Designer software, plus GUI design best practices
- Validate Pro Series control systems in multiple AV environments using acquired knowledge of installation, configuration, and commissioning principles



Extron Control Professional - ECP

Unleash the Power of Global Configurator Professional for Advanced Extron Pro Series Control Systems

Course Content

ECP is a three-day course that consists of:

- Learn Global Configurator Professional software and the advanced features used in complex system designs
- Sophisticated control system design concepts and advanced configuration techniques
- Create custom control interfaces using GUI Designer software, plus GUI design best practices
- Validate complex Pro Series control systems in multiple AV environments using acquired knowledge of installation, configuration, and commissioning principles



Extron Authorized Programmer - EAP

Learn Global Scripter and ControlScript to Design Powerful, Programmable Control Systems

Course Content

EAP is a four-day course that consists of:

- Use Global Scripter software and ControlScript, the Extron Python library for AV professionals, to program Extron Pro Series Control Systems
- Apply best practices and troubleshooting techniques to ensure optimum system performance
- Utilize methodologies for implementing and developing reusable modules for control system programs

LEARN MORE

To find out more about the Extron Control Systems Certification programs, contact your Extron S3 Customer Support Representative.

WORLDWIDE SALES OFFICES

Anaheim • Raleigh • Silicon Valley • Dallas • New York • Washington, DC • Toronto • Mexico City
Paris • London • Frankfurt • Stockholm • Amersfoort • Moscow • Dubai • Tel Aviv • Sydney • Melbourne
Bangalore • Mumbai • New Delhi • Singapore • Seoul • Shanghai • Beijing • Hong Kong • Tokyo

www.extron.com